

ASI Associated Students, Inc.

Funding Request Form

2017-18

"...For the Students, by the Students"

- Necessary Documents:**
- Event Flyer w/ A.S.I. Logo
 - CSI Event Reg. Form
 - Estimates / Food Permits
 - Event Estimates / Invoices

| Contact | Organization |
|--------------------------|---|
| Officer Name: _____ | Club/Organization: <u>Autonomous Underwater Vehicle</u> |
| Officer Title: _____ | Event Title: <u>Spring Building Event</u> |
| Address: _____ | Date(s) of Event: <u>03/01/18</u> Semester <u>Spring</u> |
| City/State/Zip: _____ | Location of Event: <u>E&T C253</u> |
| Phone & Email: _____ | Expected Total Attendance: _____ <u>15</u> |
| Officer Signature: _____ | Expected Attendance of Cal State LA Students: _____ <u>15</u> |

| Event Description and Total Cost Breakdown | |
|--|---|
| <p>Briefly describe the event: This event is hosted for students with an interest in underwater robotics to expose them to the implementation of robotic parts to a submarine. Students with experience will be teaching and demonstrating the assembly of the parts.</p> | <p>Is the event open to all Cal State LA students?: <u>Yes</u></p> <p>How will this program enhance the Cal State LA experience?: This will allow spark the interest in STEM-related fields and will allow students to work together to create a more tight-knitted community. This event can also help us recruit students into the club so that next year's members will already have some sort of</p> |

| Hospitality | |
|-------------|--------|
| Description | Amount |
| | |
| | |
| | |

| Honoraria/Contracts | |
|---------------------|--------|
| Description | Amount |
| | |
| | |
| | |

| Marketing | |
|----------------------------|----------|
| Description | Amount |
| Pinger | \$915 |
| Triple Output Power Supply | \$373.00 |
| Cameras | \$478 |
| SATA III Internal SSD | \$249.99 |

| Other | |
|---------------------|-----------|
| Description | Amount |
| Aquarian Hydrophone | \$1754.94 |
| Tether | \$600 |
| Lenses | \$189.50 |
| Oscilloscope | \$499 |

| Event Summary | |
|--|------------------------------------|
| Total Cost of Event: | \$0.00 <u>\$5099.18</u> |
| Amount Requested from A.S.I.: | <u>\$3000</u> |
| Amount from other sources: | _____ |
| What other resources are you employing for this event? | |
| | |

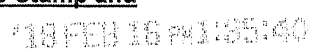
| For Office Use Only • Do Not Write Below | |
|--|---|
| Important: | |
| (1) <u>All Funding Request Forms must be turned in by 12 PM Friday, the week before the Funding Sub-Committee Meetings.</u> (2) <u>Additionally, funding request forms must be turned in no less than 10 business days (2 weeks) prior to the event.</u> (3) <u>Deadline for Request for Payment or Purchase Order (RPP) is 15 days after the event.</u> | |
| All forms must have a Time Stamp and staff initial: | |
|  |  |

STUDENT ORGANIZATION EVENT REGISTRATION FORM

COMPLETED



This form must be completed 10 business days prior to the event date. Reservations for on campus events will not be confirmed unless this form has been completed. No publicity may be distributed or posted online until this form has been submitted for off campus events or until the reservation confirmation process has been completed for on campus events. **Signatures must be completed in blue or black ink.**

NAME OF ORGANIZATION: Autonomous Underwater Vehicle (AUV) PHONE: DATE: 02/02/18
 EVENT CONTACT NAME: Diego Santillan EMAIL:
 NAME OF EVENT: Spring Building Event LOCATION: E&T C253
 EVENT DATE: 03/01/18 BEGIN TIME: 2PM END TIME: 4PM ESTIMATED ATTENDANCE: 15

TYPE OF ACTIVITY (THE UNIVERSITY'S GENERAL RELEASE WILL BE REQUIRED FOR CERTAIN EVENTS.)

- BENEFITS TO PROCEED EDUCATIONAL PROGRAM SPIRITUAL PROGRAM RECREATIONAL PROGRAM
 DANCE/PARTY SOCIAL PROGRAM COMMUNITY SERVICE CONFERENCE/CONVENTION

OTHER:

WILL YOUR EVENT INCLUDE ANY OF THE FOLLOWING? (PLEASE CHECK ALL THAT APPLY)

- SPORTS ACTIVITY OR COMPETITION FOREST/PARK CLEAN-UP INTERNATIONAL TRAVEL
 BEACH CLEAN-UP INDOOR/OUTDOOR COOKING DOMESTIC TRAVEL
 BEACH BONFIRE

PLEASE DESCRIBE THE EVENT BELOW (INCLUDE ALL ACTIVITIES):

In this event, students will learn how to integrate robotic parts onto a submarine. Leads from the RoboSub Team will be assisting interested students through the process of putting the parts together. The purpose of this event is to expose students to the electrical and mechanical aspects of engineering in hopes that it will spark their interest in STEM related fields.

WHO IS INVITED (CHECK ALL THAT APPLY):

- STUDENT ORG. MEMBERS CAL STATE LA COMMUNITY OTHER COLLEGES & UNIV. GENERAL PUBLIC GUEST LIST

Events intended for the general Cal State LA campus will be listed in the Student Organization Calendar of Events distributed in a bi-weekly email by the Center for Student Involvement. NO, I DO NOT WISH FOR MY EVENT TO BE POSTED.

WILL THE EVENT HAVE AN ADMISSION CHARGE, REGISTRATION, PARTICIPATION FEE, OR RAISE ANY PROCEEDS TO BENEFIT THE ORGANIZATION? (If yes, please complete statement regarding proceeds to benefit transactions on the back of this form) NO YES

WILL A MOVIE BE SHOWN? NO YES (If yes, please attach written proof of viewing rights.)

WILL THE EVENT HAVE SECURITY? NO YES If yes, please explain

WILL FOOD BE SERVED AT THE EVENT? NO YES

IF YES, WHO WILL PROVIDE THE FOOD? UNIVERSITY CATERING OTHER:

A completed food permit is required for all on-campus events with food unless the food is provided by University Catering.

WILL ALCOHOL BE PRESENT AT THE EVENT? NO YES. Please attach a completed request to serve alcoholic beverages. (This form may take up to two weeks for review and possible approval.)

WILL THE EVENT BE HELD IN A RESTAURANT/VENUE WHERE ALCOHOL IS AVAILABLE? NO YES Initials PLEASE LIST 2 TIPS TRAINED MEMBERS ON PAGE 2.
 If so, please affirm organization members and guests will not consume alcohol.

WILL OFF-CAMPUS MEDIA BE NOTIFIED ABOUT THE EVENT (NEWSPAPER, TV, RADIO, ETC.)? NO YES, PLEASE PROVIDE WHO WILL BE INVITED ON PAGE 2.

DOES THE STUDENT ORGANIZATION WANT TO PURCHASE SPECIAL EVENT INSURANCE FOR THIS EVENT? NO YES

Please be aware that student organization events are not covered for liability or other insurance by California State University, Los Angeles or the University-Student Union. Student organization officers or the advisor may be held personally liable. If the student organization would like to purchase Special Event Insurance for a particular event, please contact CSI.



RECEIVED
2/13/18 CA

STATEMENT REGARDING PROCEEDS TO BENEFIT TRANSACTIONS

As officers of this recognized student organization at Cal State LA, we affirm that all proceeds raised or assets assigned will be used solely for the benefit of the organization as a whole. Further, it is affirmed that no proceeds or assets of this organizations will accrue to the benefit of any officer, member, or any private person. We also affirm that all proceeds transactions for this event will comply with all University policies and procedures including but not limited to ICSUAM Policy 3141.01 and the Cal State LA Student Organization Funds Administration Policy.

Describe the admission charge, registration, participation fee, or any proceeds that will be raised to benefit the organization. Please include how much the organization will be charging for any of these proceeds.

N/A

PRESIDENT: Jorge D. Santillan SIGNATURE: [Signature] DATE: 02/13/18
 TREASURER: Albo Madrid SIGNATURE: [Signature] DATE: 02/13/18

EVENT GUIDELINES

The following guidelines are provided for the benefit of the student organization. They are intended to be followed completely. Failure to comply with any of the following guidelines may result in disciplinary action taken against the organization including suspension of recognition, events and use of facilities. More information can be found online in the Student Organization Handbook.

- CONDUCT:** The organization assumes full responsibility for the conduct of participants at the event. Any violation of University policy may subject the participants and/or the organization to disciplinary action by the Center for Student Involvement or Student Conduct.
- ALCOHOL:** In accordance with Administrative Procedure 019 - Alcoholic Beverages, any event (on or off campus) that involves the consumption of alcoholic beverages requires authorization from the University. Your organization must complete and submit a Request to Serve Alcoholic Beverages form in addition to this Event Registration Form. Please allow at least 3 weeks for this form to be reviewed by the University. Approved alcohol consumption events and events held where alcohol is available (but will not be consumed) require at least two TiPS certified members to be in attendance of the entire event. Additional guidelines may be enforced.
- PUBLICITY:** All publicity material must have the name of the sponsoring group and the following statement: "The actions and opinions of this organization do not necessarily reflect those of the students, staff, faculty, or administration of Cal State LA."
- GENERAL RELEASE:** If your event will require the use of general release waivers prior to organization member and guest participation, your organization is required to comply with all instructions provided by CSI, including submitting all completed forms and requested documents.

MY SIGNATURE BELOW INDICATES THAT I WILL TAKE RESPONSIBILITY TO ENSURE THAT THE EVENT WHICH MY ORGANIZATION IS SPONSORING WILL FOLLOW ALL GUIDELINES SET FORTH BY THE UNIVERSITY. I ACKNOWLEDGE THAT THIS EVENT AND ANY ASSOCIATED EVENT SPACE RESERVATIONS MAY BE SUBJECT TO CANCELLATION BASED ON MY ORGANIZATION'S RECOGNITION STATUS.

STUDENT ORG. OFFICER'S NAME: Jorge D. Santillan SIGNATURE (PLEASE USE BLUE OR BLACK INK ONLY): [Signature] DATE: 02/13/18
 ADVISOR'S NAME: He Shen SIGNATURE: [Signature] DATE: 02/13/18

ACKNOWLEDGMENT - FOR OFFICE USE ONLY

CENTER FOR STUDENT INVOLVEMENT (U-SU 204) SIGNATURE: [Signature] DATE: 2-13-18
 CSI VERIFIES THE ORG. IS RECOGNIZED BY THE UNIVERSITY

ASSISTANT DEAN OF STUDENTS: WELLNESS & ENGAGEMENT

GENERAL RELEASE REQUIRED FOR ALL PARTICIPANTS? NO YES DATE REQUIRED: _____

NOTIFICATIONS:

- PUBLIC AFFAIRS DATE: _____
- ATHLETICS DATE: _____
- DEPT. OF PUBLIC SAFETY DATE: _____
- FACILITIES USE COORDINATOR DATE: _____

NOTES OR UPDATES:

STUDENT ORGANIZATION EVENT REGISTRATION FORM



This form must be completed 10 business days prior to the event date. Reservations for on campus events will not be confirmed unless this form has been completed. No publicity may be distributed or posted online until this form has been submitted for off campus events or until the reservation confirmation process has been completed for on campus events. **Signatures must be completed in blue or black ink.**

NAME OF ORGANIZATION: Autonomous Underwater Vehicle (AUV) **PHONE:** **DATE:** 02/02/18
EVENT CONTACT NAME: Diego Santillan **EMAIL:**
NAME OF EVENT: Spring Building Event **LOCATION:** E&T C253
EVENT DATE: 03/01/18 **BEGIN TIME:** 2PM **END TIME:** 4PM **ESTIMATED ATTENDANCE:** 15

TYPE OF ACTIVITY (THE UNIVERSITY'S GENERAL RELEASE WILL BE REQUIRED FOR CERTAIN EVENTS.)

BENEFITS TO PROCEED EDUCATIONAL PROGRAM SPIRITUAL PROGRAM RECREATIONAL PROGRAM
DANCE/PARTY SOCIAL PROGRAM COMMUNITY SERVICE CONFERENCE/CONVENTION

OTHER:

WILL YOUR EVENT INCLUDE ANY OF THE FOLLOWING? (PLEASE CHECK ALL THAT APPLY)

SPORTS ACTIVITY OR COMPETITION FOREST/PARK CLEAN-UP INTERNATIONAL TRAVEL
BEACH CLEAN-UP INDOOR/OUTDOOR COOKING DOMESTIC TRAVEL
BEACH BONFIRE

PLEASE DESCRIBE THE EVENT BELOW (INCLUDE ALL ACTIVITIES):

In this event, students will learn how to integrate robotic parts onto a submarine. Leads from the RoboSub Team will be assisting interested students through the process of putting the parts together. The purpose of this event is to expose students to the electrical and mechanical aspects of engineering in hopes that it will spark their interest in STEM related fields.

WHO IS INVITED (CHECK ALL THAT APPLY):

STUDENT ORG. MEMBERS CAL STATE LA COMMUNITY OTHER COLLEGES & UNIV. GENERAL PUBLIC GUEST LIST

Events intended for the general Cal State LA campus will be listed in the Student Organization Calendar of Events distributed in a bi-weekly email by the Center for Student Involvement. NO, I DO NOT WISH FOR MY EVENT TO BE POSTED.

WILL THE EVENT HAVE AN ADMISSION CHARGE, REGISTRATION, PARTICIPATION FEE, OR RAISE ANY PROCEEDS TO BENEFIT THE ORGANIZATION? (If yes, please complete statement regarding proceeds to benefit transactions on the back of this form) NO YES

WILL A MOVIE BE SHOWN? NO YES (If yes, please attach written proof of viewing rights.)

WILL THE EVENT HAVE SECURITY? NO YES If yes, please explain

WILL FOOD BE SERVED AT THE EVENT? NO YES
IF YES, WHO WILL PROVIDE THE FOOD? UNIVERSITY CATERING OTHER:
A completed food permit is required for all on-campus events with food unless the food is provided by University Catering.

WILL ALCOHOL BE PRESENT AT THE EVENT? NO YES. Please attach a completed request to serve alcoholic beverages. (This form may take up to two weeks for review and possible approval.)

WILL THE EVENT BE HELD IN A RESTAURANT/VENUE WHERE ALCOHOL IS AVAILABLE? NO YES Initials PLEASE LIST 2 TIPS TRAINED MEMBERS ON PAGE 2.
If so, please affirm organization members and guests will not consume alcohol.

WILL OFF-CAMPUS MEDIA BE NOTIFIED ABOUT THE EVENT (NEWSPAPER, TV, RADIO, ETC.)? NO YES, PLEASE PROVIDE WHO WILL BE INVITED ON PAGE 2.

DOES THE STUDENT ORGANIZATION WANT TO PURCHASE SPECIAL EVENT INSURANCE FOR THIS EVENT? NO YES

Please be aware that student organization events are not covered for liability or other insurance by California State University, Los Angeles or the University-Student Union. Student organization officers or the advisor may be held personally liable. If the student organization would like to purchase Special Event Insurance for a particular event, please contact CSI.

STATEMENT REGARDING PROCEEDS TO BENEFIT TRANSACTIONS

As officers of this recognized student organization at Cal State LA, we affirm that all proceeds raised or assets assigned will be used solely for the benefit of the organization as a whole. Further, it is affirmed that no proceeds or assets of this organizations will accrue to the benefit of any officer, member, or any private person. We also affirm that all proceeds transactions for this event will comply with all University policies and procedures including but not limited to ICSUAM Policy 3141.01 and the Cal State LA Student Organization Funds Administration Policy.

Describe the admission charge, registration, participation fee, or any proceeds that will be raised to benefit the organization. Please include how much the organization will be charging for any of these proceeds.

N/A

PRESIDENT: Jorge D. Santillan SIGNATURE: [Signature] DATE: 02/13/18
 TREASURER: Albo Madrid SIGNATURE: [Signature] DATE: 02/15/18

EVENT GUIDELINES

The following guidelines are provided for the benefit of the student organization. They are intended to be followed completely. Failure to comply with any of the following guidelines may result in disciplinary action taken against the organization including suspension of recognition, events and use of facilities. More information can be found online in the Student Organization Handbook.

- CONDUCT:** The organization assumes full responsibility for the conduct of participants at the event. Any violation of University policy may subject the participants and/or the organization to disciplinary action by the Center for Student Involvement or Student Conduct.
- ALCOHOL:** In accordance with Administrative Procedure 019 - Alcoholic Beverages, any event (on or off campus) that involves the consumption of alcoholic beverages requires authorization from the University. Your organization must complete and submit a Request to Serve Alcoholic Beverages form in addition to this Event Registration Form. Please allow at least 3 weeks for this form to be reviewed by the University. Approved alcohol consumption events and events held where alcohol is available (but will not be consumed) require at least two TIPS certified members to be in attendance of the entire event. Additional guidelines may be enforced.
- PUBLICITY:** All publicity material must have the name of the sponsoring group and the following statement: "The actions and opinions of this organization do not necessarily reflect those of the students, staff, faculty, or administration of Cal State LA."
- GENERAL RELEASE:** If your event will require the use of general release waivers prior to organization member and guest participation, your organization is required to comply with all instructions provided by CSI, including submitting all completed forms and requested documents.

MY SIGNATURE BELOW INDICATES THAT I WILL TAKE RESPONSIBILITY TO ENSURE THAT THE EVENT WHICH MY ORGANIZATION IS SPONSORING WILL FOLLOW ALL GUIDELINES SET FORTH BY THE UNIVERSITY. I ACKNOWLEDGE THAT THIS EVENT AND ANY ASSOCIATED EVENT SPACE RESERVATIONS MAY BE SUBJECT TO CANCELLATION BASED ON MY ORGANIZATION'S RECOGNITION STATUS.

STUDENT ORG. OFFICER'S NAME: Jorge D. Santillan SIGNATURE (PLEASE USE BLUE OR BLACK INK ONLY): [Signature] DATE: 02/13/18
 ADVISOR'S NAME: He Shen SIGNATURE: [Signature] DATE: 02/13/18

ACKNOWLEDGMENT - FOR OFFICE USE ONLY

CENTER FOR STUDENT INVOLVEMENT (U-SU 204) SIGNATURE: _____ DATE: _____
 CSI VERIFIES THE ORG. IS RECOGNIZED BY THE UNIVERSITY _____
 ASSISTANT DEAN OF STUDENTS: WELLNESS & ENGAGEMENT _____
 GENERAL RELEASE REQUIRED FOR ALL PARTICIPANTS? NO YES DATE REQUIRED: _____
NOTIFICATIONS:
 PUBLIC AFFAIRS DATE: _____ ATHLETICS DATE: _____
 DEPT. OF PUBLIC SAFETY DATE: _____ FACILITIES USE COORDINATOR DATE: _____

NOTES OR UPDATES:

Spring Building Event

Organization: AUV

Interested in underwater robotics? Want to learn about robots even though you are not an engineering major?

Come join us in the construction of our newest Robosub, **Eagle2!**

We welcome all persons with a slight interest in underwater Robotics!

We will be teaching interested students how to mount different robotic parts onto the RoboSub! So don't miss out!

All you have to bring is yourself and your curiosity!

Hope to see you all there!

Date: March 1st

Location: E&T C253

Time: 3-4PM

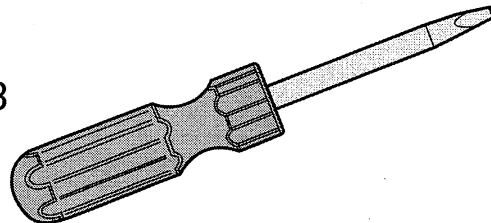
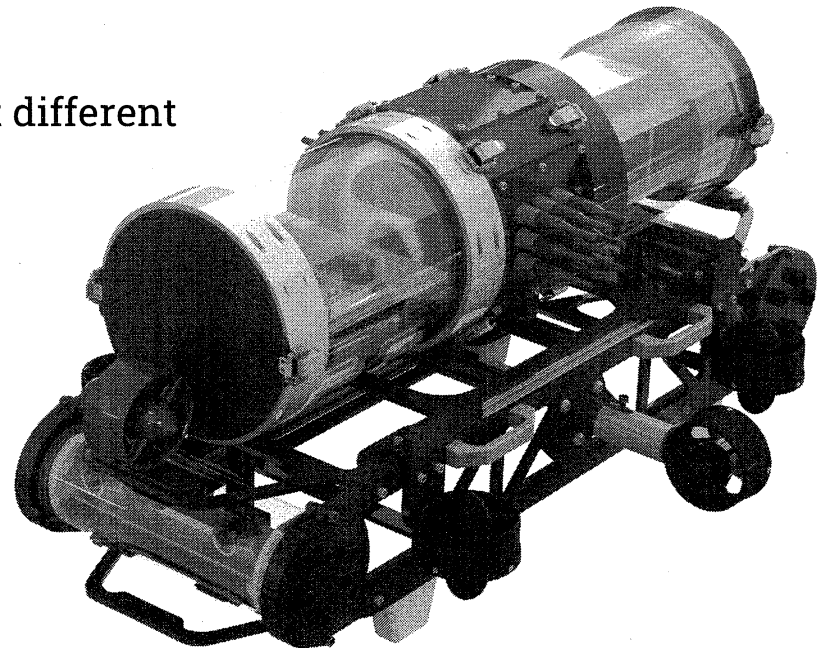
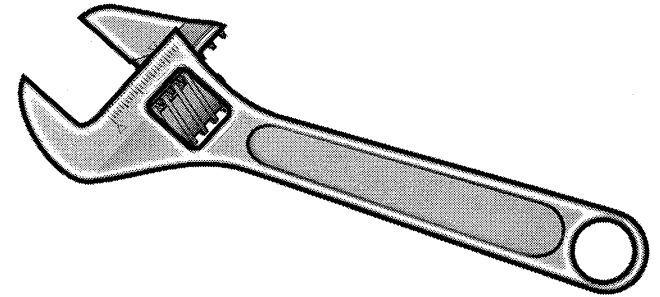

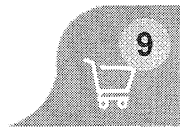

HYDROPHONES

ACCESSORIES

SUPPORT

MEDIA

HOME / CART CONTENTS

CART CONTENTS

Product

Unit price

Quantity

Total price



PA-4 Hydrophone Preamplifier

\$94.99

6

\$569.94

CODE: PA4

Configuration:

P48 (phantom power assembly)

Output: N/A

Use Group:

for Aquarian Scientific hydrophones



AS-1 Hydrophone

\$395.00

3

\$1,185.00

CODE: AS-1

Calibration:

Standard Quality Control

Weight:

No Weight



Subtotal \$1,754.94

Shipping cost → CALCULATE

Total cost \$1,754.94

CONTINUE SHOPPING

RECALCULATE

PROCEED TO CHECKOUT

California State University, Los Angeles
 College of Engineering
 Attn: Mr. Diego Santillan
 5151 State University Drive,
 Los Angeles CA, 90032
 USA

Quote: 17042105
Customer Number: 810950 - Fax: (Faxnr)
Case Number: 415439

Charlotte, 2/09/2018

Dear Mr. Santillan,

In reply to your inquiry and according to our general terms of business we are pleased to quote you for the following components:

| Item | Qty. | Product Description | Unit Price | Total Price |
|-------------|------|---|------------|-------------|
| DFK 22AUC03 | 2 | The Imaging Source "One for all" camera, USB 2.0, 1/3" CMOS, color, max resolution 744x480, ROI to increase speed, C/CS-mount, WITHOUT lens and cables. | USD 239.00 | USD 478.00 |

USD 478.00

Shipping & Handling: * *Shipping cost will vary due to package weight and value of goods* *

Terms of Payment: Credit card (Amex, Visa, MasterCard), wire transfer, EFT

Delivery Time: Upon confirmation of receipt of payment

Quote Validity: 30 days

To place orders, please contact our office at **704-370-0110** and provide your **customer number**, the **quote number**, or the six digit **case number** located in the subject line of the e-mail.

Please do not hesitate to contact our staff with any further questions. We very much look forward to your order.

Yours sincerely,

Jeisson Alba

California State University, Los Angeles
 College of Engineering
 Mr. Diego Santillan
 5151 State University Drive,
 Los Angeles CA, 90032
 USA

Quote: 17053002
Customer Number: 810950 - Fax: (Faxnr)
Case Number: 418011

Charlotte, 2/09/2018

Dear Mr. Santillan,

In reply to your inquiry and according to our general terms of business we are pleased to quote you for the following components:

| Item | Qty. | Product Description | Unit Price | Total Price |
|-------------|------|--|------------|-------------|
| TBL 1.4 5MP | 2 | The Imaging Source 5 MP board lens 12x0.5 mm Format = 1/2.5" Focal Length = 1.4 mm Iris = 2.0 | USD 74.95 | USD 149.90 |
| TLH CCS | 2 | The Imaging Source holder for board lenses (M12x0.5), C/CS-Mount | USD 19.80 | USD 39.60 |

USD 189.50

Shipping & Handling: ** Shipping cost will vary due to package weight and value of goods **

Terms of Payment: Credit card (Amex, Visa, MasterCard), wire transfer, EFT

Delivery Time: Upon confirmation of receipt of payment

Quote Validity: 30 days

To place orders, please contact our office at **704-370-0110** and provide your **customer number**, the **quote number**, or the six digit **case number** located in the subject line of the e-mail.



NEW & INTERESTING FINDS ON AMAZON

EXPLORE



amazon prime

Industrial & Scientific

100mhz oscilloscope



Explore baby product deals

Departments

Your Pickup Location

Browsing History

EN

Hello, Diego

Account & Lists

Orders

Prime



Industrial & Scientific

Lab

Test & Measurement

Safety

Janitorial & Facilities

Food Service

Education

Material Handling

Materials

Metalworking

Back to search results for "100 Mhz oscilloscope"



Siglent Technologies

Siglent Technologies SDS1102X LCD Digital Oscilloscope, 100 MHz

★★★★★ 26 customer reviews
| 21 answered questions

Price: \$499.00 ✓prime

In Stock.

Want it Tuesday, Feb. 13? Order within 18 hrs 36 mins and choose One-Day Shipping at checkout. Details

Ships from and sold by Amazon.com. Gift-wrap available.

Used & new (3) from \$450.00 + \$12.45 shipping

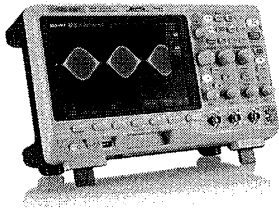

Click to open expanded view

Downloads CAD Models, MSDS, Manuals

Specifications for this item

| | | | |
|--------------------|---------------------|----------------------------|-------------|
| Part Number | SDS1102X | Item Weight | 2.2 pounds |
| Measurement System | US | Length | 13.4 inches |
| UPC | 7027561027185200163 | Manufacturer Series Number | SDS1000X |
| Brand Name | Siglent Technologie | Model Number | SDS1102X |
| Color | Grey | Number of Items | 1 |
| Display Type | LCD | Range | 100 MHz |
| EAN | 0718520016959011521 | UNSPSC Code | 25170000 |
| Height | 7.3 inches | Width | 4.85 inches |

See more product details

Packaging may reveal contents. Choose Conceal Package at checkout.

Share

Qty: 1

Add to Cart

Buy Now

Turn on 1-Click ordering for this browser

Ship to:

Jorge Santillan- South Pasaden - 91030

Add to List

Add to your Dash Buttons

Other Sellers on Amazon

\$499.00 Add to Cart

+ Free Shipping

Sold by: Transcat Inc.

Used & new (3) from \$450.00 + \$12.45 shipping

Have one to sell? Sell on Amazon

Frequently bought together

Total price: \$514.46

Add all three to Cart

Add all three to List



JW Fishers

Underwater search equipment (it pays to own!)

Send us an Email
info@jwfishers.com

Get in Touch
(800) 822-4744

Q Search

- Home
- About JWF
- Order
- Products
- Data Sheets
- Industry News
- Photos/Videos
- Support

PLACE YOUR ORDER

Select a product to view available options

Note: Shipping charges shown are for UPS ground service in the Continental United States

- > Hand Held Detectors
- > Boat Towed Detectors
- > Side Scan and Scanning Sonar Systems
- ▼ Pingers
 - SFP-1 Single Mid-Frequency Pinger
 - MFP-1 Multi Mid-Frequency Pinger
 - SLFP-1 Single 12kHz Low-Frequency Pinger
 - MLFP-1 Multi Low-Frequency Pinger
 - PR-1 Pinger Receiver
- > Transponders
- > Other Acoustic Devices
- > Light Systems
- > Underwater Video Systems
- > Miscellaneous

Products and Options

SFP-1 Single Mid-Frequency Pinger and Options

- SFP-1 Single Mid-Frequency Pinger
 - Specify operating frequency: 22, 32, 37.5, 40, or 50kHz (custom frequencies also available)
 - Custom frequency (specify in Notes)
 - Extended Operation Housing (3 times normal operating time)
 - Very Long Duration Housing with electronics (12 times normal operating time)
 - External 10' cable for a remote on/off switch (switch not provided)
 - External 10' cable with remote on/off switch
 - Carrying case (holds four standard pingers, or two pingers and the PR-1 pinger receiver)

Price of Product(s) with selected options: \$895
 Shipping costs: \$20
 Total Price: \$915

| | |
|------------------|---|
| First Name: | First Name |
| Last Name: | Last Name |
| Your Email: | Your Email Address |
| Address: | Address |
| City: | City |
| State: | State |
| Zip/Postal Code: | Zip Code |
| Country: | Country |
| State/Province: | State |
| Phone: | Phone |
| Fax: | Fax |
| Notes: | Additional questions or comments regarding your JWFishers Order |

Reset

Submit

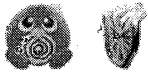

NEW & INTERESTING FINDS ON AMAZON

EXPLORE



amazon prime

Industrial & Scientific

samsung 860 PRO 512GB



Explore baby product deals

Departments

Your Pickup Location

Browsing History

EN



Hello, Diego

Account & Lists

Orders

Prime



Cart

Industrial & Scientific

Lab

Test & Measurement

Safety

Janitorial & Facilities

Food Service

Education

Material Handling

Materials

Metalworking

Back to search results for "samsung 860 PRO 512GB"

Samsung

Samsung 860 PRO 512GB 2.5 Inch SATA III Internal SSD (MZ-76P512BW)

★★★★★ 4 customer reviews

Price: \$249.99 ✓prime | FREE One-Day

Get \$70 off instantly: Pay \$179.99 upon approval for the Amazon Prime Rewards Visa Card.

Note: Available at a lower price from other sellers, potentially without free Prime shipping.

In Stock.

Get it tomorrow, Feb. 12. Order within 18 hrs 49 mins and choose One-Day Shipping at checkout. Details

Ships from and sold by Amazon.com. Gift-wrap available.

Capacity: 500 GB

1 TB

2 TB

4 TB

250 GB

500 GB

Service: Get professional installationDetails

Without expert installation

Include installation and data transfer +\$98.99

See more

- Powered by Samsung V-NAND Technology. Optimized Performance for Everyday Computing
- Enhanced Performance: Sequential Read/Write speeds up to 560MB/s and 530MB/s respectively
- Ideal for mainstream PCs and laptops for personal, gaming and business use
- Hardware/Software Compatibility: Windows 8/Windows 7/Windows Server 2003 (32-bit and 64-bit), Vista (SP1 and above), XP (SP2 and above), MAC OSX, and Linux
- Included Contents: 2.5" (7mm) SATA III (6Gb/s) SSD & User Manual (All Other Cables, Screws, Brackets Not Included).

Compare with similar items

New (2) from \$245.00 & FREE shipping.

Report incorrect product information.

Share



Qty: 1

Add a Protection Plan:

- 3-year Data Recovery Plan for \$14.99
- 2-year Data Recovery Plan for \$9.99

Add to Cart

Buy Now

Turn on 1-Click ordering for this browser

Ship to:

Jorge Santillan- South Pasaden - 91030

Add to List

Add to your Dash Buttons

Other Sellers on Amazon

\$245.00 Add to Cart

+ Free Shipping

Sold by: Tax Free Shop

New (2) from \$245.00 & FREE shipping.

Have one to sell?

Sell on Amazon

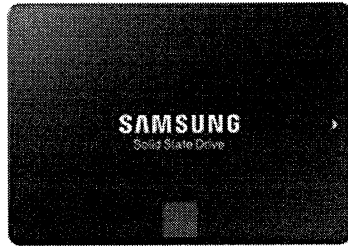

Roll over image to zoom in

CRUCIAL BY MICRON

New Crucial MX500 SSD

> [Shop now](#)

Crucial MX500 250GB 3D



Ad feedback

Frequently bought together



+

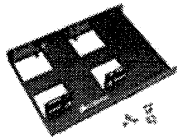

Total price: \$257.97

Add both to Cart

Add both to List

This item: Samsung 860 PRO 512GB 2.5 Inch SATA III Internal SSD (MZ-76P512BW) \$249.99

Corsair Dual SSD Mounting Bracket 3.5" CSSD-BRKT2 \$7.98

Sponsored products related to this item (What's this?)

Page 1 of 4

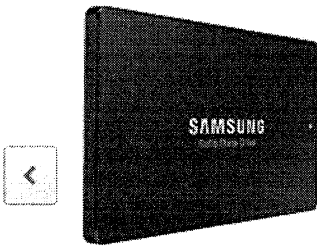

Samsung MZ7LM960HCHP-00003 Solid State Drive MZ7LM960HCHP-00003... \$289.99



INTEL / HP 512GB PRO 6000P SERIES 3D1 TLC AES 256-BIT SED SINGLE SIDED 80MM (2280) ... \$187.99 ✓prime



Ableconn IIIDE-MSAT mSATA SSD to 2.5-Inch IDE Adapter Converter with Aluminum Frame ... \$28.99 ✓prime

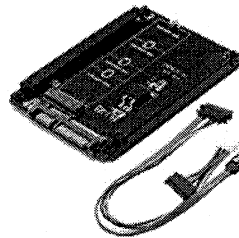

Mailiya 2.5in SATA III 3 to M.2 NGFF SSD Connector Converter Adapter Card with SATA... \$17.99 ✓prime



DREVO X1 Series 240GB SSD 2.5-inch Solid State Drive SATA3 Read 550MB/S Write 470MB/S \$69.99 ✓prime

Ad feedback

Customers who viewed this item also viewed

Page 1 of 11

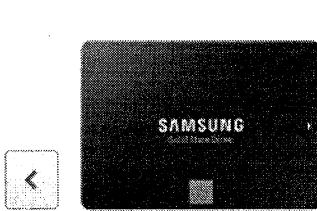

Samsung 860 EVO 500GB 2.5 Inch SATA III Internal SSD (MZ-76E500B/AM) \$169.99 ✓prime

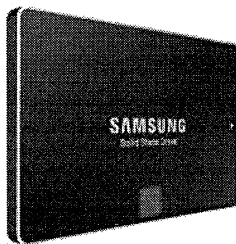

Samsung 850 PRO - 512GB - 2.5-Inch SATA III Internal SSD (MZ-7KE512BW) \$241.48

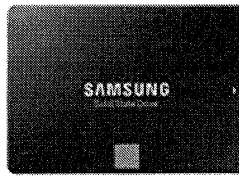

Samsung 860 EVO 1TB 2.5 Inch SATA III Internal SSD (MZ-76E1T0B/AM) \$299.99 ✓prime

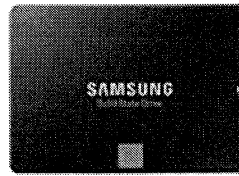

Samsung 860 EVO 250GB 2.5 Inch SATA III Internal SSD (MZ-76E250B/AM) \$94.99 ✓prime

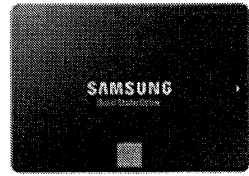

Samsung 860 EVO 4TB 2.5 Inch SATA III Internal SSD (MZ-76E4T0B/AM) \$1,399.99 ✓prime

Special offers and product promotions

Capacity: 500 GB

- Your cost could be **\$179.99** instead of **\$249.99!** Get a **\$70 Amazon.com Gift Card** instantly upon approval for the **Amazon Prime Rewards Visa Card** Apply now

Have a question?

Find answers in product info, Q&As, reviews

From the manufacturer

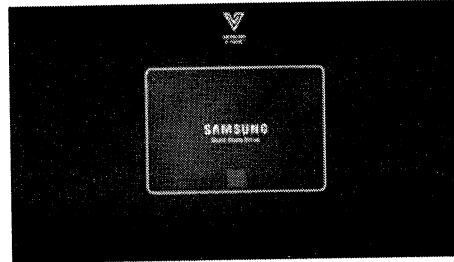

[View larger](#)

Industry leading reliability

Powered by the latest V-NAND technology and a robust algorithm-based controller, the 860 PRO readily handles heavy workloads of high-end PCs, workstations and NAS (Network Attached Systems) to give lasting assurance to gamers, IT and creative professionals.

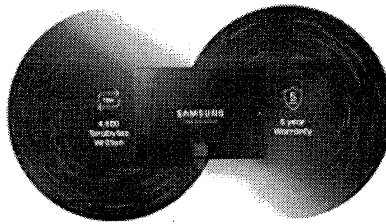
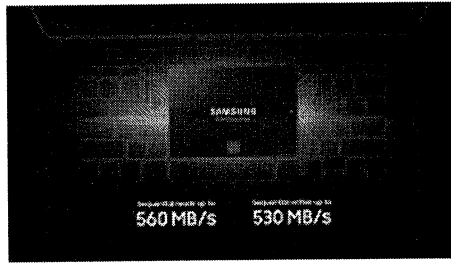

[View larger](#)

Superior endurance

Under heavy workloads, endurance is everything. Safely store and render 4K videos and 3D data used by the latest applications, up to 10.7x higher TBW* than the previous 850 PRO. The latest V-NAND technology gives you industry-leading endurance backed by a 5-year or up to 4,800 TBW limited warranty.

* Terabyte Written.

Warrantied TBW for 860 PRO: 300 TBW for 256 GB model, 600 TBW for 512 GB model, 1,200 TBW for 1 TB model, 2,400 TBW for 2 TB model and 4,800 TBW for 4 TB model.

5-years or TBW, whichever comes first. For more information on the warranty, please find the enclosed warranty statement in the package.

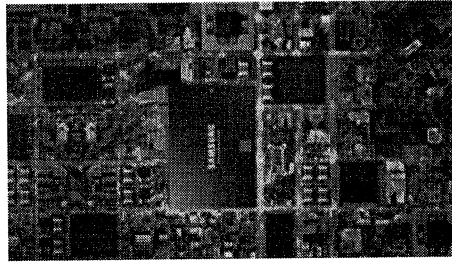

Smart compatibility

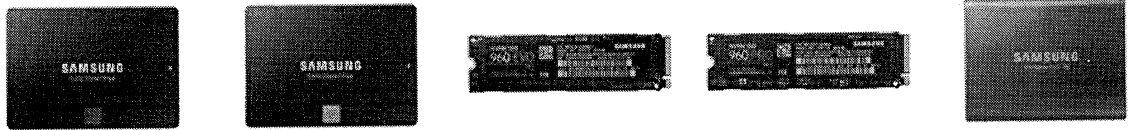

| | Samsung 860 PRO Solid State Drive | Samsung 860 EVO Solid State Drive | Samsung 960 EVO Solid State Drive | Samsung 960 PRO Solid State Drive | Samsung T5 Portable SSD |
|------------------------------------|--|--|--|--|-------------------------------|
| Capacity | 256GB 512GB 1TB 2TB 4TB | 250GB 500GB 1TB 2TB 4TB | 250GB 500GB 1TB | 512GB 1TB 2TB | 250GB 500GB 1TB 2TB |
| Internal/External | Internal | Internal | Internal | Internal | External |
| Form Factor | 2.5 inch | 2.5 inch M.2 2280 mSATA | M.2 2280 | M.2 2280 | Portable |
| Interface | SATA III 6Gb/s | SATA III 6Gb/s | NVMe PCIe | NVMe PCIe | USB 3.1 |
| Max. Sequential Read Speed | Up to 560 MB/s | Up to 550 MB/s | Up to 3,200 MB/s | Up to 3,500 MB/s | Up to 540 MB/s |
| Max. Sequential Write Speed | Up to 530 MB/s | Up to 520 MB/s | Up to 1,900 MB/s | Up to 2,100 MB/s | Up to 520 MB/s |
| NAND Type | Samsung V-NAND | Samsung V-NAND | Samsung V-NAND | Samsung V-NAND | Samsung V-NAND |
| Warranty | Limited 5 Years | Limited 5 Years | Limited 3 Years | Limited 5 Years | Limited 3 Years |
| Recommended For | Gaming Professional and Everyday Computing | Gaming Professional and Everyday Computing | Ultimate Performance Gaming and Professional Computing | Ultimate Performance Gaming and Professional Computing | Fast, Secure External Storage |

Compare with similar items

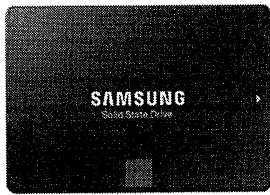

This item Samsung 860 PRO 512GB 2.5 Inch SATA III Internal SSD (MZ-76P512BW)

Add to Cart

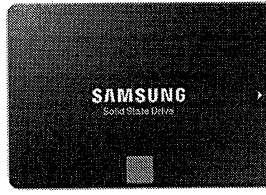

Samsung 850 EVO 500GB 2.5-Inch SATA III Internal SSD (MZ-75E500B/AM)

#1 Best Seller

Add to Cart



Samsung 850 PRO - 512GB - 2.5-Inch SATA III Internal SSD (MZ-7KE512BW)

Add to Cart

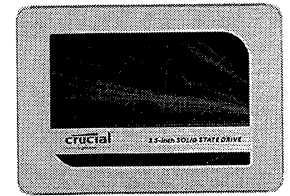

Crucial MX500 500GB 3D NAND SATA 2.5 Inch Internal SSD - CT500MX500SSD1(Z)

#1 New Release

Add to Cart

Customer Rating

★★★★☆ (4)

★★★★☆ (17557)

★★★★☆ (3388)

★★★★☆ (70)

Price

\$249⁹⁹

\$149⁹⁹

\$241⁴⁸

\$134⁹⁵

Shipping

✓prime

✓prime

FREE Shipping

✓prime

Sold By

Amazon.com

Amazon.com

J-Electronics

Amazon.com

Data Transfer Rate

—

6

6

6 Gb per second

Device Type

Internal Solid State Drive

Solid State Drives

Solid State Drives

Internal Solid State Drive

Digital Storage Capacity

—

500 GB

512 GB

—

Flash Memory Installed Size

—

500

512

500

Hard-Drive Size

500 GB

500 GB

512 GB

—

Hard Disk Form Factor

2.5 in

2.5 in

2.5 in

2.5 in

Hardware Connectivity

SATA 6.0 Gb/s

SATA 6.0 Gb/s

SATA 6.0 Gb/s

SATA 6.0 Gb/s

Hardware Platform

PC, Mac

PC

PC; Mac

PC; Mac

Item Dimensions

2.76 x 3.94 x 0.27 in

2.75 x 3.94 x 0.28 in

2.75 x 3.94 x 0.27 in

0.28 x 4.06 x 2.76 in

Item Weight

—

1.92 ounces

0.32 ounces

3.53 ounces

Memory Storage Capacity

—

500 GB

512 GB

—

Model Year

2018

2014

2014

2017

Optical Storage Read Speed

—

540

550

560 MB/s

Writing speed of the optical memory

—

520

520

510 MB/s

Size

500 GB

500 GB

512 GB

500GB

Product description

Capacity: 500 GB

Samsung 860 PRO solid state drive is the SSD to trust. Based on 3D V-NAND flash, Samsung offers enhanced read/write performance, endurance and power management efficiency. With multiple form factors, the 860 PRO is ideal for mainstream PCs and laptops.

Product information

Capacity: **500 GB**

Technical Details

[Collapse all](#)

Summary

Hard Drive 500 GB

Other Technical Details

| | |
|---------------------------|---------------------------|
| Brand Name | Samsung |
| Item model number | MZ-76P512BW |
| Hardware Platform | PC, Mac |
| Item Weight | 2.4 ounces |
| Product Dimensions | 3.9 x 2.8 x 0.3 inches |
| Item Dimensions L x W x H | 3.94 x 2.76 x 0.27 inches |

Additional Information

| | |
|------------------------|--|
| ASIN | B07836C6YV |
| Customer Reviews | ★★★★★ 4 customer reviews 5.0 out of 5 stars |
| Best Sellers Rank | #39 in Computers & Accessories > Data Storage > Internal Solid State Drives |
| Shipping Weight | 2.4 ounces (View shipping rates and policies) |
| Domestic Shipping | Currently, item can be shipped only within the U.S. and to APO/FPO addresses. For APO/FPO shipments, please check with the manufacturer regarding warranty and support issues. |
| International Shipping | This item can be shipped to select countries outside of the U.S. Learn More |
| Date First Available | January 10, 2018 |

Warranty & Support

Amazon.com Return Policy: You may return any new computer purchased from Amazon.com that is "dead on arrival," arrives in damaged condition, or is still in unopened boxes, for a full refund within 30 days of purchase. Amazon.com reserves the right to test "dead on arrival" returns and impose a customer fee equal to 15 percent of the product sales price if the customer misrepresents the condition of the product. Any returned computer that is damaged through customer misuse, is missing parts, or is in unsellable condition due to customer tampering will result in the customer being charged a higher restocking fee based on the condition of the product. Amazon.com will not accept returns of any desktop or notebook computer more than 30 days after you receive the shipment. New, used, and refurbished products purchased from Marketplace vendors are subject to the returns policy of the individual vendor.

Manufacturer's warranty can be requested from customer service. [Click here to make a request to customer service.](#)

Feedback

If you are a seller for this product, would you like to [suggest updates through seller support?](#)

[Would you like to tell us about a lower price?](#)

[Sponsored products related to this item](#) (What's this?)

Page 1 of 10



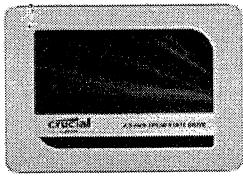

Crucial MX500 1TB 3D NAND SATA 2.5 Inch Internal SSD - CT1000MX500SSD1(Z)
 ★★★★★ 70
 \$259.99 ✓prime

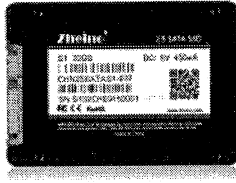

Zheino S1 2.5 Inch SATA III 32GB SSD 2D MLC Solid State Drive (7mm) for Desktop Lap...
 \$24.99 ✓prime



Toshiba X300 8TB Performance Desktop and Gaming Hard Drive 7200 RPM 128MB Cache SAT...
 ★★★★★ 369
 \$249.99 ✓prime



INTEL / HP 512GB PRO 6000P SERIES 3D1 TLC AES 256-BIT SED SINGLE SIDED 80MM (2280) ...
 ★★★★★ 3
 \$187.99 ✓prime

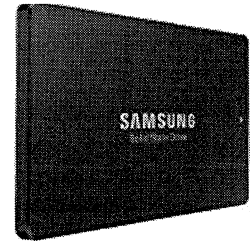

Samsung MZ7LM960HCHP-00003 Solid State Drive
 MZ7LM960HCHP-00003...
 \$289.99

Ad feedback

Féria GLAM GRUNGE

SHOP NOW >

LOREAL PARIS

Ad feedback

Customer Questions & Answers

See questions and answers

Customer reviews

★★★★★ 4

5.0 out of 5 stars *

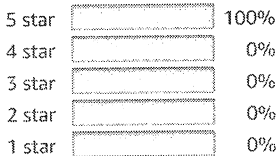

Share your thoughts with other customers

[Write a customer review](#)

See all 4 customer reviews >

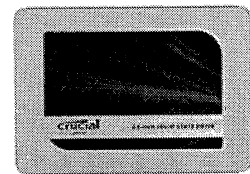

Crucial MX500 1TB 3D NAND SATA 2.5 Inch I...
 ★★★★★ 70
 \$259.99 ✓prime

[Shop Now](#)

Top customer reviews



Rip

★★★★★ **Simply the best 2.5" SATA SSD you can get.**

January 28, 2018

Capacity: 500 GB | Verified Purchase

Benchmarks from the OCZ Vertex4 240 it replaced:

Sequential Read (Q= 32,T= 1) : 484.404 MB/s

Sequential Write (Q= 32,T= 1) : 429.296 MB/s

Random Read 4KiB (Q= 8,T= 4) : 277.425 MB/s [67730.7 IOPS]

Random Write 4KiB (Q= 8,T= 4) : 251.379 MB/s [61371.8 IOPS]

Random Read 4KiB (Q= 32,T= 1) : 179.869 MB/s [43913.3 IOPS]

Random Write 4KiB (Q= 32,T= 1) : 158.458 MB/s [38686.0 IOPS]

Random Read 4KiB (Q= 1,T= 1) : 32.417 MB/s [7914.3 IOPS]

Random Write 4KiB (Q= 1,T= 1) : 92.879 MB/s [22675.5 IOPS]

And this Samsung 860 PRO 512GB drive:

Sequential Read (Q= 32,T= 1) : 2399.917 MB/s

Read more

Comment | 11 people found this helpful. Was this review helpful to you? Report abuse



R. C.

★★★★★ **Arrived today and it's pretty awesome. I've tried 7**

January 30, 2018

Capacity: 250 GB | Verified Purchase

Arrived today and it's pretty awesome. I've tried 7, maybe 8 or so different brands of SSD drives, and various models within those brands over the years, and have to say that once again going with a Samsung doesn't disappoint. This Pro model is fast and snappy. Of the 2 testing programs I use the 860 Pro has outscored everything else i've ever tested. Simply awesome.

Comment | 4 people found this helpful. Was this review helpful to you? Report abuse



eim23x

★★★★★ **Five Stars**

February 10, 2018

Capacity: 500 GB | Verified Purchase

Great for upgrading from 7200 drives

Comment | Was this review helpful to you? Report abuse



Dakster21

★★★★★ **AWESOME SSD! Although I have only had it for ...**

January 29, 2018

Capacity: 500 GB | Verified Purchase

AWESOME SSD! Although I have only had it for a few days now, it works great and I intend on using it for many years to come!

Comment | One person found this helpful. Was this review helpful to you? Report abuse

See all 4 reviews

Write a customer review

Search customer reviews



Search

Set up an Amazon Giveaway



Amazon Giveaway allows you to run promotional giveaways in order to create buzz, reward your audience, and attract new followers and customers. Learn more about Amazon Giveaway

This item: Samsung 860 PRO 512GB 2.5 Inch SATA III Internal SSD (MZ-76P512BW)

Set up a giveaway

Customers who bought this item also bought

| | | | | |
|--|---|---|--|--|
| | | | | |
| <p>Samsung 860 EVO 500GB 2.5 Inch SATA III Internal SSD (MZ-76E500B/AM) ★★★★☆ 21 \$169.99 ✓prime</p> | <p>Samsung 860 EVO 250GB 2.5 Inch SATA III Internal SSD (MZ-76E250B/AM) ★★★★☆ 19 \$94.99 ✓prime</p> | <p>Samsung 850 PRO - 512GB - 2.5-Inch SATA III Internal SSD (MZ- 7KE512BW) ★★★★☆ 3,388 \$241.48</p> | <p>Corsair Dual SSD Mounting Bracket 3.5" CSSD-BRKT2 ★★★★☆ 1,353 \$7.98 ✓prime</p> | <p>Samsung 850 PRO - 256GB - 2.5-Inch SATA III Internal SSD (MZ- 7KE256BW) ★★★★☆ 3,388 \$144.99 ✓prime</p> |

The ultimate
cool-weather staples
amazon essentials

[See more >](#)

Ad feedback

[Back to top](#)

Get to Know Us

- [Careers](#)
- [About Amazon](#)
- [Investor Relations](#)
- [Amazon Devices](#)

Make Money with Us

- [Sell on Amazon](#)
- [Sell Your Services on Amazon](#)
- [Sell on Amazon Business](#)
- [Sell Your Apps on Amazon](#)
- [Become an Affiliate](#)
- [Advertise Your Products](#)
- [Self-Publish with Us](#)
- [Become an Amazon Vendor](#)
- [> See all](#)

Amazon Payment Products

- [Amazon Rewards Visa Signature Cards](#)
- [Amazon.com Store Card](#)
- [Amazon.com Corporate Credit Line](#)
- [Shop with Points](#)
- [Credit Card Marketplace](#)
- [Reload Your Balance](#)
- [Amazon Currency Converter](#)

Let Us Help You

- [Your Account](#)
- [Your Orders](#)
- [Shipping Rates & Policies](#)
- [Amazon Prime](#)
- [Returns & Replacements](#)
- [Manage Your Content and Devices](#)
- [Amazon Assistant](#)
- [Help](#)



English

United States

Amazon Music
Stream millions
of songs

Amazon Drive
Cloud storage
from Amazon

6pm
Score deals
on fashion brands

AbeBooks
Books, art
& collectibles

ACX
Audiobook Publishing
Made Easy

Alexa
Actionable Analytics
for the Web

Amazon Business
Everything For
Your Business

AmazonFresh

AmazonGlobal

Home Services

Amazon Inspire

Amazon Rapids

Amazon Restaurants

Amazon Video Direct

| | | | | | | |
|---|--|--|--|---|--|---|
| Groceries & more Right To Your Door | Ship Orders Internationally | Handpicked Pros Happiness Guarantee | Digital Educational Resources | Fun stories for kids on the go | Food delivery from local restaurants | Video Distribution Made Easy |
| Amazon Web Services Scalable Cloud Computing Services | Audible Download Audiobooks | AudiobookStand Discount Audiobooks on Disc | Book Depository Books With Free Delivery Worldwide | Box Office Mojo Find Movie Box Office Data | ComiXology Thousands of Digital Comics | CreateSpace Indie Print Publishing Made Easy |
| DPRreview Digital Photography | East Dane Designer Men's Fashion | Fabric Sewing, Quilting & Knitting | Goodreads Book reviews & recommendations | IMDb Movies, TV & Celebrities | IMDbPro Get Info Entertainment Professionals Need | Junglee.com Shop Online in India |
| Kindle Direct Publishing Indie Digital Publishing Made Easy | Prime Now FREE 2-Hour Delivery on Everyday Items | Prime Photos Unlimited Photo Storage Free With Prime | Shopbop Designer Fashion Brands | TenMarks.com Math Activities for Kids & Schools | Warehouse Deals Open-Box Discounts | Whole Foods Market America's Healthiest Grocery Store |
| | Withoutabox Submit to Film Festivals | Woot! Deals and Shenanigans | Zappos Shoes & Clothing | Souq.com Shop Online in the Middle East | Subscribe with Amazon Discover & try subscription services | |

Categories

New Products

(<https://www.bluerobotics.com/product-category/new/>)

Books

(<https://www.bluerobotics.com/product-category/books/>)

Buoyancy & Ballast

(<https://www.bluerobotics.com/product-category/buoyancy-ballast/>)

Cables and Tethers

(<https://www.bluerobotics.com/product-category/cables/>)

Electronics

Batteries and Chargers

Cameras

Leak Sensor

Lights

Electronics Packages

Sensors

Speed Controllers (ESCs)

Tether Interfaces

Underwater GPS

Parts

(<https://www.bluerobotics.com/product-category/parts/>)

Penetrators & Connectors

(<https://www.bluerobotics.com/product-category/connectors/>)

ROV

BlueROV2

Servos

(<https://www.bluerobotics.com/product-category/servos/>)

Thrusters & Motors

Motors

T100/T200 Thrusters

Spare Thruster Parts

Tools

(<https://www.bluerobotics.com/product-category/tools/>)

Watertight Enclosures

2" Series

3" Series

4" Series

6" Series

8" Series

Swag

(<https://www.bluerobotics.com/product-category/swag/>)

Dings & Dents

(<https://www.bluerobotics.com/product-category/dings-n-dents/>)

Retired

(<https://www.bluerobotics.com/product-category/retired/>)

Home (<https://www.bluerobotics.com/>) / Store (<https://www.bluerobotics.com/store/>) / Cables and Tethers (<https://www.bluerobotics.com/product-category/cables/>) / Fathom Slim ROV Tether

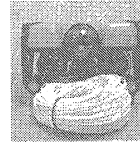
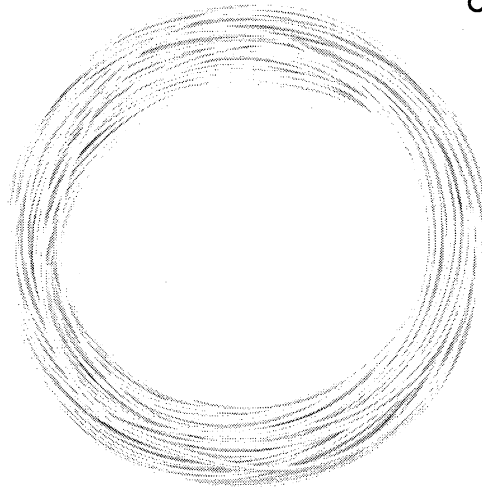

Fathom Slim ROV Tether

\$0.00 – \$1,300.00

This high-performance, low-drag tether is less than 4mm in diameter and has single pair of wires. It's perfect for trave deep dives, and long-distance dives. A polyurethane foam jacket makes it rugged and abrasion resistant. Comes with pre-installed cable penetrator.

Note: The *Fathom Slim* Tether is currently in limited release. It will eventually be available as an official option for the BlueROV2.

Tether Length (m)

200 m (656 ft)

Clear

\$600.00

1

Add to Cart

SKU: CAB-NBPUF-1UTP-26AWG Category: Cables and Tethers (<https://www.bluerobotics.com/product-category/cables/>)

Description

Description

Note: The *Fathom Slim* Tether is currently in limited release. It will eventually be available as an official option for the BlueROV2.

The *Fathom Slim* Tether is a high performance tether cable designed specifically for ROVs and other subsea applications and optimized for light weight, high strength, and transportability. It is neutrally buoyant, has 350 lb breaking strength, and is embedded with water-blocking fibers to seal any leaks. The tether has a diameter of 4.0mm and is much slimmer than the vast majority of ROV tethers.

The tether carries one unshielded twisted pair (UTP) of 26AWG wire. The core of the cable contains Kevlar strands for strength and Dacron fibers for space filling. Both fibers are impregnated with waterblocking compound to block any leaks caused by nicks or rips in the cable. The high-visibility yellow polyurethane foam jacket resists abrasion and provides neutral buoyancy.

This tether really shines when it comes to its size. Its slim profile makes it ultra low-drag, making it ideal for deep dives, high current dives, and long distance dives where the drag from the tether is really noticeable. The size also makes it incredibly portable and easy to handle. A hundred meter tether weighs just 3 lb (1.4 kg) and can be managed by hand very easily.

Since the tether only has two wires, it can only be used for the primary communication of the BlueROV2. There are no spare twisted pairs when using this cable, which means that it is not compatible with the Water Linked Analog Locator and is not ideal for applications where you need extra tether pairs.

Contents

- 1 x Slim Tether Cable (choose length above)
- 1 x Cable Penetrator (not included with 1m length)

Resources

- Documentation (<http://docs.bluerobotics.com/fathom-slim/>)
- Specifications (<http://docs.bluerobotics.com/fathom-slim/#specifications>)
- Electrical Characteristics (<http://docs.bluerobotics.com/fathom-slim/#specifications>)

Related products



NEW & INTERESTING FINDS ON AMAZON

EXPLORE



Industrial & Scientific

bench power supply



Explore baby product deals

Departments

Your Pickup Location

Browsing History



Hello, Diego

Account & Lists

Orders

Prime



Cart

Industrial & Scientific

Lab

Test & Measurement

Safety

Janitorial & Facilities

Food Service

Education

Material Handling

Materials

Metalworking

Back to search results for "bench power supply"



Siglent Technologies

Siglent Technologies SPD3303X-E Triple Output Power Supply

★★★★☆ 10 customer reviews

| 10 answered questions

Price: \$389.00 **prime**

In Stock.

Want it Tuesday, Feb. 13? Order within 7 hrs 26 mins and choose **Two-Day Shipping** at checkout. Details

Ships from and sold by Amazon.com. Gift-wrap available.

New (2) from \$373.00 & FREE shipping.

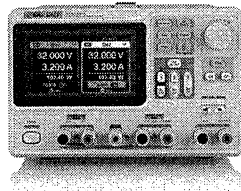

Click to open expanded view

Specifications for this item

| | | | |
|-------------|----------------------|----------------------------|-------------|
| Part Number | SPD3303X-E | Length | 11.0 inches |
| UPC | 718520016356 | Manufacturer Series Number | SPD3300X |
| Brand Name | Siglent Technologies | Model Number | SPD3303X-E |
| EAN | 0718520016356 | Number of Items | 1 |
| Height | 5.6 inches | UNSPSC Code | 41113600 |
| Item Weight | 17.6 pounds | Width | 8.6 inches |

[See more product details](#)

Share

Qty:

Add to Cart

Buy Now

Turn on 1-Click ordering for this browser

Ship to:

Jorge Santillan- South Pasaden - 91030

Add to your Dash Buttons

Other Sellers on Amazon

\$373.00

+ Free Shipping

Sold by: Saelig Company

New (2) from \$373.00 & FREE shipping.

Have one to sell?

Downloads CAD Models, MSDS, Manuals

Packaging may reveal contents. Choose **Conceal Package** at checkout.

Frequently bought together

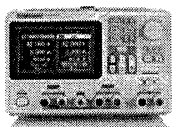

+



Total price: \$395.97

This item: Siglent Technologies SPD3303X-E Triple Output Power Supply \$389.00

AUV Project Building Event on March 01, 2018

| Item | Description | Qty | Link | Cost/Unit | Total |
|--------------------|--|-----|---|--------------|-------------------|
| DFK 22AUC03 | The imaging Source "One for All" camera USB 2.0, 1/3 CMOS, Color, | 2 | https://www.theimagingsource.com/products/industrial-cameras/usb-2.0-color/dfk22auc03/ | \$239.00 | \$478.00 |
| TBL 1.4 5MP | The image source 5 M board lens 12x0.5 mm Format = 1/1.5', Focal Length = 1,4 mm, Iris = 2.0 | 2 | https://www.theimagingsource.com/products/optics/board-lenses/megapixel/ | \$79.95 | \$149.90 |
| TLH CCS | The Image Source holder for board lenses (M12x0.5), C/CS-Mount | 2 | https://www.theimagingsource.com/search/?q=TLH+CCS+ | \$19.80 | \$39.60 |
| SSD | Samsung 860 PRO 512GB 2.5 Inch SATA 111 Internal SSD | | https://www.amazon.com/Samsung-512GB-Inch-Internal-MZ-76P512BW/dp/B07836C6YV/ref=nav_custrec_sig_nin?s=electronics&ie=UTF8&qid=1518394448&sr=1-3&keywords=SATA+drive+512GB& | \$273.74 | \$273.74 |
| Tether | Fathom Slim ROV tether | 1 | https://www.bluerobotics.com/store/cables/cab-nbpuf-1utp-26awg/ | \$600.00 | \$600.00 |
| Bench Power Supply | Siglent Technologies SPD330X-E Thriple Power Supply | 1 | https://www.amazon.com/Siglent-Technologies-SPD330X-Triple-Output/dp/B01410O424/ref=sr_1_14?ie=UTF8&qid=1518395498&sr=8-14&keywords=bench+power+supply | \$389.00 | 389 |
| Oscilloscope | Siglent Technologies SD1102X LCD Digital Oscilloscope | 1 | https://www.amazon.com/Siglent-Technologies-SDS1102X-Digital-Oscilloscope/dp/B01410O5D2/ref=sr_1_3?ie=UTF8&qid=1518395761&sr=8-3&keywords=100mhz+oscilloscope | \$499.00 | \$499.00 |
| Hydrophones | AS-1 Hydrophone | 3 | https://www.aquarianaudio.com/as-1-hydrophone.html | \$395.00 | \$1,185.00 |
| Preamplifier | PA-4 Hydrophone Preamplifier | 3 | https://www.aquarianaudio.com/pa4.html | \$94.99 | \$569.94 |
| Pinger | JW Single Frequency Pinger | 1 | http://www.jwfishers.com/order.html#product-name=sfp1 | \$915.00 | \$915.00 |
| | | | | Total | \$5,099.18 |